

# USER MANUAL

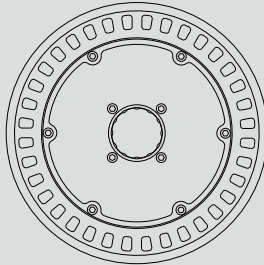

## Plug-in Sensor

### DANGER

Warning against hazards that may result in material damage in case of non-observance.

### CAUTION

Risk of injury caused by a falling luminaire.

In case of improper mounting, the luminaire or luminaire elements may fall down and cause personal injuries and material damage.

- X The installation must be performed by a trained skilled electrician only.
- X Mount only on a ceiling which is suitable for mounting.
- X Use suitable screws and dowels only.
- X Use only the delivered fastening elements or other suitable fastening elements available from the manufacturer.
- X Mount all securing elements.

### WARNING

Risk of electrocution due to live components.

In case of incorrect connection, the housing of the luminaire or the wire ropes may carry electric voltage and cause severe injuries.

- X Have the luminaire connected by a skilled electrician only.
- X The luminaire must be connected to a mains supply with protective earth conductor.
- X Connect the grounding cable mounted on the holding plate to the protective earth conductor terminal.

### NOTICE

Material damage if the admissible total power consumption is exceeded.

Damage or destruction of the luminaire.

- X Do not daisy chain more than six luminaires.

Installation

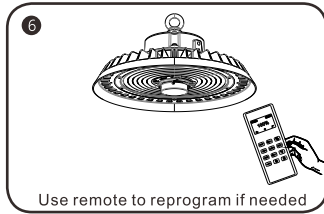
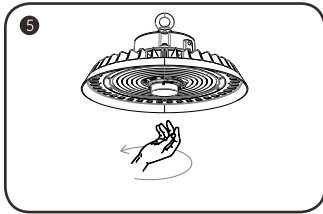
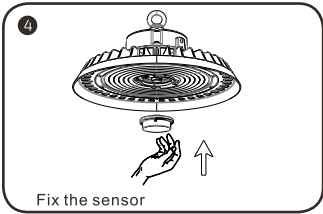
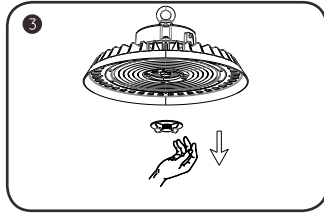
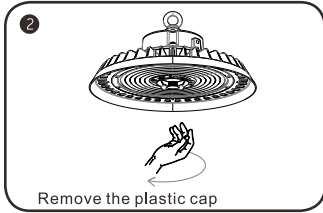
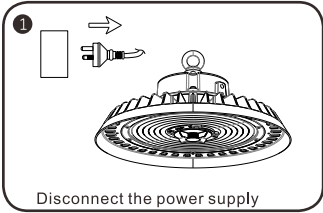

Working program

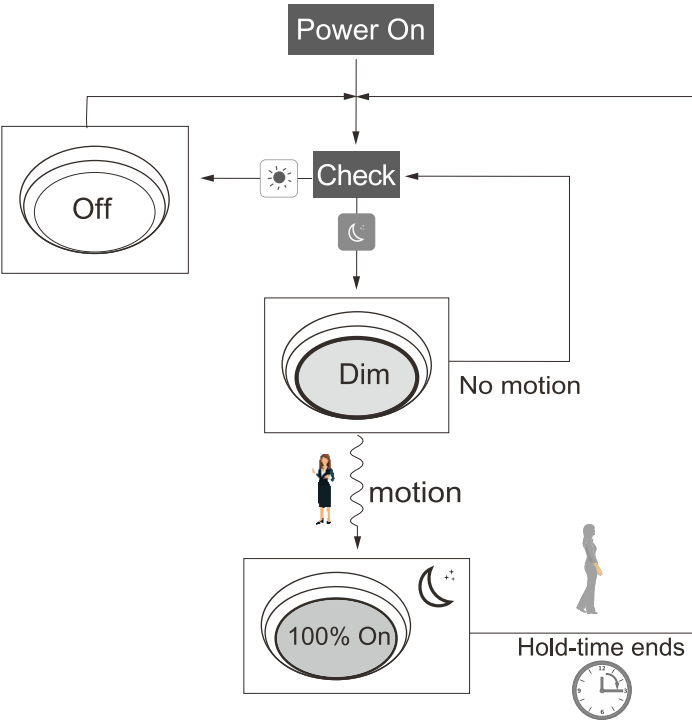

Sensor Options

- Micro-wave & Daylight
- PIR & Daylight
- Daylight Sensor

Detection

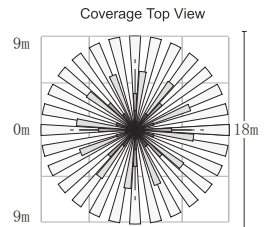
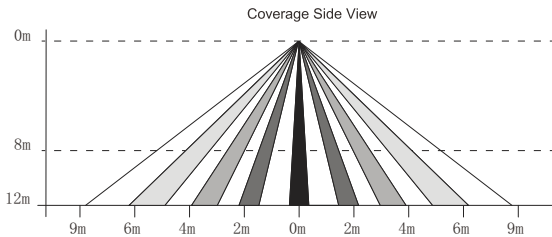

Daylight Harvesting Function



The light dims to stand-by period after hold-time and stays on selected minimum dimming level.



The light switches off completely after the stand-by period.

- Setting on this demonstration:
- BRIGHTNESS: 100%
- SENSITIVITY: 100%
- HOLD TIME: 30MIN
- STAND BY DIM: 30%
- STAND BY TIME: 1MIN

Re-programmable

Fixed on up to 12 meters after installation, the high bay will be not easy to adjust the working program. But the user may not satisfied with the performance and sensitivity or Dim level is needed to adjust for different season. In order to make the extra work easy and no machines are needed, one remote control is provided to re-program the sensor.

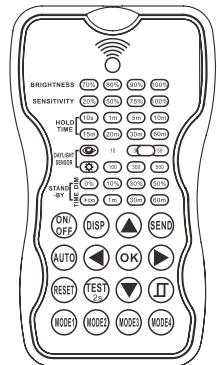

Distance range: 12m  
Battery: AAx2

# Sensor Remote Programmer OPERATION INSTRUCTIONS

## SPECIFICATIONS

Power supply	2 x AAA 1.5V battery, Alkaline preferred
Carrying case	RC-100 in carrying case
Upload range	Up to 15 m (50 ft. )
Op. temperature	0°C~50°C (32°F~122°F)
Dimensions	123 x 70 x 20.3 mm (4. 84" x 2.76" x 0. 8")

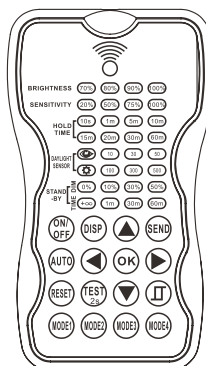

## **WARNING**

**Remove the batteries from compartment if the remote will not be used in 30 days.**

## **OVERVIEW**





















The remote control Wireless IR Configuration Tool is a handheld tool for remote configuration of IR-enabled fixture integrated sensors. The tool enables device to modify via pushbutton without ladders or tools, and stores up to four sensor parameter modes to speed configuration of multiple sensors.

The remote control send sensor setting at mounting height up to 50 feet. The device can display previously established sensor parameters, copy parameters and send new parameters or store parameter profiles. For projects where identical settings may be desired across a large number of areas or spaces, this capability provides a streamlined method of configuration. Settings can be copied throughout a site, or in different sites.

## **LED indicators**

LED	DESCRIPTION	LED	DESCRIPTION
BRIGHTNESS	High end trim turning function(To Set the output level of connected lighting during occupancy)		The daylight sensor stops working, and all motion detected could turn on the lighting fixture, no matter how bright the natural light is.
SENSITIVITY	To set the occupancy sensing sensitivity of the Sensor	STAND-BY DIM	To set the output level of connected lighting during vacancy. The sensor will regulate the lighting output at the set level. Setting the STAND-BY DIM level at 0 means light full off during vacancy.
HOLD TIME	The time that the Sensor will turn off(if you choose stand-by level is 0) or dim the light to a low level after the area is vacated	STAND-BY TIME	To represents the time that the Sensor will keep the light at low dim level after the HOLD TIME elapsed.
DAYLIGHT SENSOR	To represents various thresholds of natural light level for the Sensor .		

## Button Operation

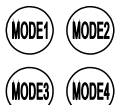

BUTTON	DESCRIPTION	BUTTON	DESCRIPTION
	Press the  button, the light goes to permanent on or permanent off mode, and the sensor is disabled. (MUST press  button to quit this mode for Setting.		Press  button, the sensor starts to function and all settings remain the same as the latest status before the light is switched on/off.
	Display the current/lastest setting parameters in LED indicators(the LED indicators will on for showing the setting parameters).		The button  is for testing purpose sensitivity only. after you choose sensitivity thresholds, then you press  button, The sensor goes to test mode(hold time is only 2s) automatically ,meanwhile the stand-by period and daylight sensor are disabled. Press  button to quit from this mode.
	Press  button, all settings go back to settings of dip Switch in sensor.		
	Enter in the setting condition, the parameter leds of remote control will flash to be selected, and Navigate to UP and Down for choose selected parameters in LED indicators.		Navigate to LEFT and RIGHT for choose selected parameters in LED indicators.
	Confirm the selected parameters selected parameters in remote control.		Open and close smart daylight Sensor. Press  or  Enter in the setting condition, the parameter leds of remote control will flash to be selected, Press  for open or close smart daylight Sensor.
	Press  button, upload the current parameters to sensor(s), the led light which the sensor connects will on/off as confirm.		
	4 Scene modes with preset parameters which are available to be changed and saved in modes.		







## Setting

The SETTING Content contains all available settings and parameters for remote sensors. It allows you to change the available control, parameters, and operation of the sensor from factory default or current parameters.

**Change multiple settings of sensor(s)**



1. Press  button, the remote control leds will show the latest parameters you set.

**NOTE:** if you push  button before, you must push  button to unlock the sensor.

2. Press  or  enter in the setting condition, the parameter leds of remote control will flash to be selected, navigate to the desired setting by pressing     to select the new parameters.

3. Press ok to confirm all setting and saving.

4. Aim at the target sensor and press to upload the new parameter, the led light which the sensor connects will on/off as confirm.

**NOTE:** the setting works key step is by Push  or , enter in the setting condition.

**NOTE:** the led light which the sensor connects will on/off after getting the new parameter as confirm.

**NOTE:** If you press  button, the remote led indicators will show the latest parameters which were sent.

Setting menu

### Change multiple setting of sensors with smart photocell sensor Open

1. Press **DISP**, the remote led indicators will show the latest parameters.
2. Press **▲** or **▼** enter in the setting condition, the parameter Led indicators of remote control will flash to be selected.
3. Press **□**, 2 led indicators will flash in daylight sensor settings, select daylight **10** **30** **50** as setpoint to light on Automatically, select daylight **100** **300** **500** as setpoint to light off Automatically.
4. Press **OK** to confirm all setting and saving.
5. Aim at the target sensor and press **SEND** to upload the new parameter. The led light which the sensor connects will on/off.

**NOTE:** **□** is disabled by default.

1. Open or close the smart daylight sensor by push **□** when remote control is in setting condition.
2. When the smart daylight sensor open, 2 Led indicators are flash in daylight sensor setting. select daylight **10** **30** **50** as setpoint to light on Automatically, select daylight **100** **300** **500** as setpoint to light off automatically. When smart daylight sensor close, 1 Led indicator is flash in the daylight sensor setting for choose daylight sensor threshold.
3. When the smart daylight sensor open, the stand-by time is only **+∞**.
4. Smart daylight sensor takes place of normal photocell sensor and works independently.
5. See **Daylight Sensor Function**.

### Corridor Function

This function inside the motion sensor to achieve tri-level control, for some areas which require a light change notice before switch-off. The sensor offers 3 levels of light: 100%-->dimmed light (natural light is insufficient)-->off; and 2 periods of selectable waiting time: motion hold-time and stand-by period; Selectable daylight threshold and freedom of detection area.

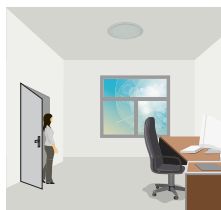

With sufficient natural light, the light does not switch on when presence is detected.

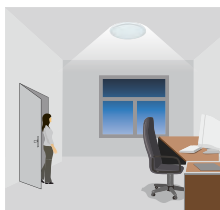

With insufficient natural light, the sensor switches on the light automatically when presence is detected.

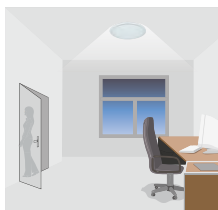

After hold-time, the light dims to stand-by level if the surrounding natural light is below the daylight threshold.

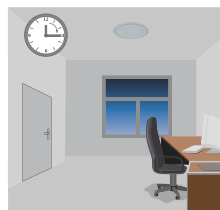

Light switches off automatically after the stand-by period elapses.

### Daylight Sensor Function

Open the daylight sensor by push **□** when remote control is in setting condition.

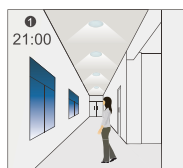

The light switches on at 100% when there is movement detected.



The light dims to stand-by level after the hold-time.

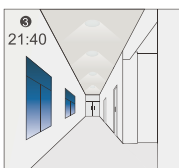

The light remains in dimming level at night.

Settings on this demonstration:  
 Hold-time: 30min  
 setpoint to light on: 50lux  
 setpoint to light off: 300lux  
 Stand-by Dim: 10%  
 Stand-by period: +∞  
 (when the smart photocell sensor open, the stand-by time is only +∞)

① → ② → ③ goes in cycle at night ...  
 100% on when movement detected, and dims to 10% in long absence.



When the natural light level exceeds setpoint off to light, the light will turn off even if when the space is occupied.

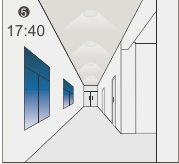

The light automatically turns on at 10% when natural light is insufficient (no motion).

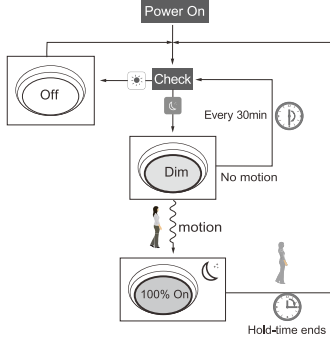

**Corridor Function VS Daylight Sensor Function.**

1. In corridor function, turn on the light MUST by natural light level lower daylight sensor setting and Occupancy. In smart daylight sensor function, turn on the light by natural light level lower daylight setpoint to light on even if vacancy.
2. In corridor function, turn off light by stand-by time finish if vacancy. In smart daylight sensor function, turn off the light by natural light level higher than daylight setpoint to light off even if occupancy.
3. In smart daylight sensor function, natural light level lighter/lower than daylight setpoint to light off/on MUST keep at least 1mintue, that will turn off/on the light automatically.

**About RESET and MODE(1,2,3,4)**

The remote control comes with 4 Scene MODES which are not default. You may make desired parameters and save as the new MODE(1,2,3,4) to configure the installed sensors.

**RESET:** all settings go back to settings of DIP Switch in sensor.

**SCENE MODES(1 2 3 4)**

Application	Scene Options	Brightness	Detection Area	Hold Time	Stand-by Time	Stand-by Dim Level	Daylight Sensor
Indoor	Mode 1	100%	75%	5min	30min	30%	☀️
Indoor	Mode 2	100%	75%	1min	+∞	30%	☀️
Indoor	Mode 3	100%	75%	5min	30min	30%	30LUX
Outdoor	Mode 4	100%	75%	1min	+∞	30%	☀️ (30LUX/300LUX)

Change the MODES:

1. press **MODE1** / **MODE2** / **MODE3** / **MODE4** button, the remote control Led indicators show existing parameters.
2. press **▲** / **▼** / **◀** / **▶** to select the new parameters.
3. Press **OK** to confirm all parameters and saving in the mode.

**UPLOAD**

The upload function allows you to configure the sensor with all parameters in one operation. You may select CURRENT SETTING parameters or the MODE for uploading. Current setting parameters or the MODE are displayed in Remote control .

**Upload the current parameters to sensor(s), and duplicate the sensor parameters form one to another**



1. Press **DISP** button or press **MODE1** / **MODE2** / **MODE3** / **MODE4** , all parameters are displayed in Remote control.  
**Note:** check if all parameters are correct , if not, change them.
2. Aim at the sensor and press **SEND** button , the light that sensor connects will be on/off as confirm.  
**Note:** if other sensor need same parameters, just aim at the sensor and press **SEND** button.

----- | (20300024)

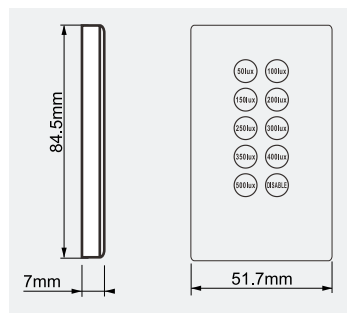
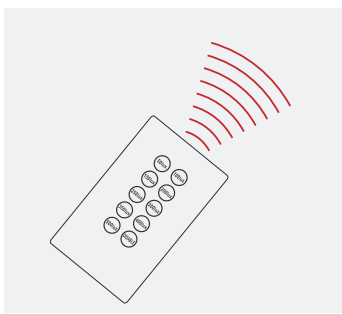
### REMOTE CONTROLS FOR USER-FRIENDLY CONTROL OF MOTION AND OCCUPANCY DETECTORS



#### Technical Data

 20300024  
 3 Volt (inclusive)  
 depending on lighting conditions  
 clouded or dark : 5 to 6 m;  
 sunshine : 2 to 3 m  
 L84.5 x W51.7x H7mm

#### Program Functions

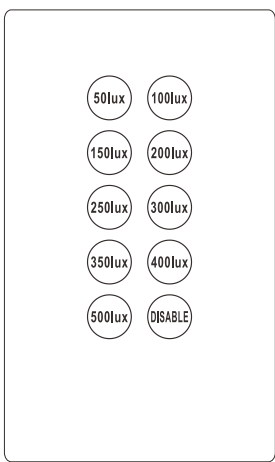

#### RC-104 Remote Control- For daylight harvesting function

50lux/100lux/150lux/200lux/250lux/300lux/350lux/400lux /500lux stands for different values of daylight harvest.

-When you press the "50lux" button, the daylight harvest value is set at 50lux and so on.

-Press the "DISABLE" button to exit daylight harvest mode.



### Microwave sensor

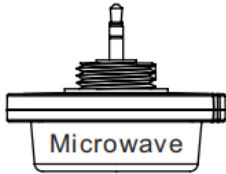

1. Microwaves cannot penetrate metal. Please avoid installing the product in a closed or semi-closed metal luminaire to ensure that there is no metal or glass shielding above the product. If the antenna must pass through the metal plate, please ensure that the top of the sensor is close to the metal plate.

2. The recommended installation distance between microwave sensors is greater than 3m, and should be far away from wireless devices such as switches and routers to avoid radio interference. The recommended installation distance between the two is greater than 3m; Low/high frequency signals interfere with the normal operation of the microwave sensor antenna.

3. Long-term vibration equipment or moving objects should be avoided around the microwave sensor. The generated vibration signal will be regarded as a mobile signal to trigger induction. Therefore, the installation location should be as far away as possible from large metal equipment, ventilation ducts, air-conditioning outlets, exhaust outlets, and smoke exhaust. If there are pets passing by in the detection area, the induction may be triggered.

4. This product is suitable for indoor installation. When installed in semi-outdoor or outdoor, wind and rain may be regarded as a mobile signal to trigger induction; when the sensor is installed in metal lamps, metal reflective surfaces or in a small closed environment, microwave It will be reflected multiple times and cause false triggering. Please reduce the induction sensitivity or contact the manufacturer for technical support.

5. Product specifications and parameters may be optimized without prior notice.

6. The low-brightness effect will be different when equipped with different 0-10V drivers; since the light threshold test conditions are sunny, no shadows and light diffuse reflection, in different time periods and under different weather conditions, the illuminance detected by the light sense will vary.

7. The sensing distance of the product is related to the moving speed of the object, the size of the object, the installation height of the product, the installation angle, the installation environment, and the material of the reflector.

8. For the new installation environment, it is recommended to install and test at least 5pcs prototypes before batch installation.

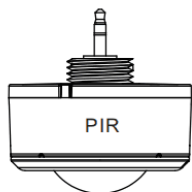

1. The working temperature of the PIR infrared probe is  $-30^{\circ}\text{C}\sim+70^{\circ}\text{C}$ . The infrared probe can work within this temperature range, but the test distance of the product will be affected by the change of temperature.

2. Under different working temperatures, the corresponding distance ratios are as follows.

\* The PIR infrared sensor has the farthest sensing distance under the temperature of  $-10^{\circ}\text{C}\sim+33^{\circ}\text{C}$ , and the sensing range is 100%;

\* The PIR infrared sensor has a small sensing distance at  $+33^{\circ}\text{C}\sim+45^{\circ}\text{C}$  temperature, and the general distance reduction ratio is between 10%~50%;

\* When the temperature of the PIR infrared sensor is  $+45^{\circ}\text{C}\sim+70^{\circ}\text{C}$ , the sensing distance will decrease rapidly, and the distance will basically be reduced to about 2 meters;

\*The sensing distance of PIR infrared sensor will be small at  $-10^{\circ}\text{C}\sim-20^{\circ}\text{C}$  temperature, and the general distance reduction ratio is between 10%~50%;

\*When the temperature of PIR infrared sensor is  $-20^{\circ}\text{C}\sim-30^{\circ}\text{C}$ , the sensing distance will decrease rapidly, and the distance will basically be reduced to about 2 meters;

3. In actual use, it is recommended that the working temperature be used within the range of  $-15^{\circ}\text{C}\sim+40^{\circ}\text{C}$ .